

Instructions for use

English

Comfort Duett



Important Safety Instructions

1. Read these instructions.
2. Keep these instructions.
3. Heed all warnings.
4. Follow all instructions.
5. Do not use this apparatus near water.
6. Clean only with dry cloth.
7. Do not use near any heat sources such as radiators, heat registers, stoves, or other apparatus (including amplifiers) that produce heat.
8. Do not defeat the safety purpose of the polarized or grounding-type plug. A polarized plug has two blades with one wider than the other. A grounding type plug has two blades and a third grounding prong. The wide blade or the third prong are provided for your safety. If the provided plug does not fit into your outlet consult an electrician for replacement of the obsolete outlet. (Only when using polarized plug.)
9. Protect the power cord from being walked on or pinched particularly at plugs convenience receptacles. and the point where they exit from the apparatus.
10. Only use attachments/accessories specified by Comfort Audio AB.
11. Unplug this apparatus during lightning storms or when unused for long periods of time.
12. Refer all servicing to qualified service personnel. Servicing is required when the apparatus has been damaged in any way such as power-supply cord or plug is damaged liquid has been spilled or objects have fallen into the apparatus,

the apparatus has been exposed to rain or moisture does not operate normally or has been dropped.

- 13.** Start listening at a low volume.
- 14.** Too high a volume can seriously damage your hearing.
- 15.** Do not disassemble the product.
- 16.** Should the product break open because of damage, service should only be done by qualified service personnel.
- 17.** The product contains sensitive electronic equipment and must be handled carefully.
- 18.** Never charge the product in closed, unaired spaces such as handbags, cases or other closed storage bags.
- 19.** Only use batteries and power supply specified by Comfort Audio AB.
- 20.** The product and the batteries must not be exposed to extreme heat such as sunlight, fire, etc.
- 21. **WARNING!**** The necklace should not be used if there is a risk of getting stuck, e.g. in a machine or other objects.
- 22.** Do not keep the product connected to the charger if it is not used for a longer period.

Product symbols

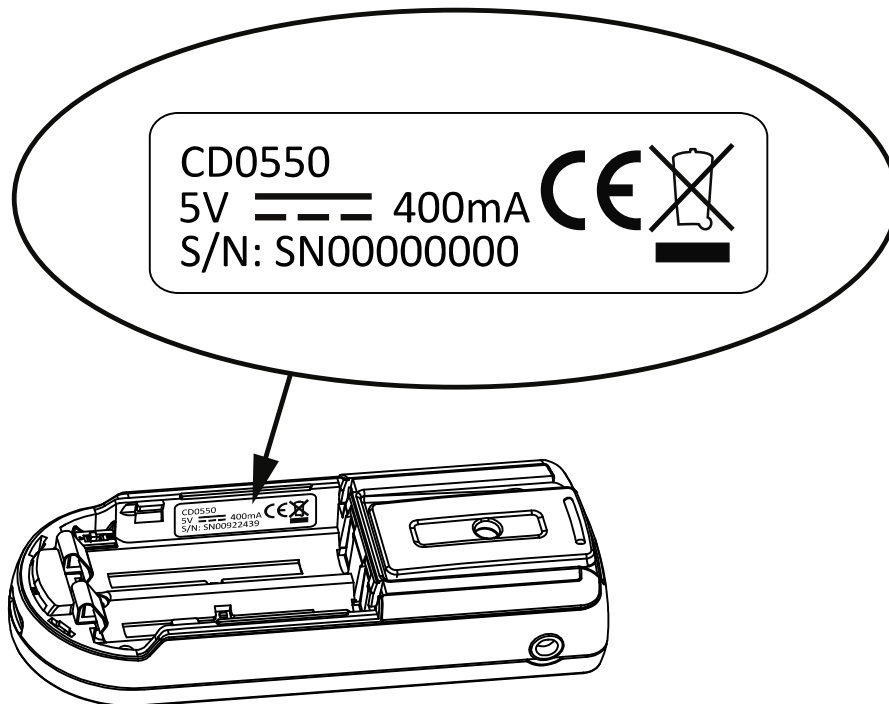

The product complies with the European directive 93/42/EEC, including amendments, concerning medical devices. The product complies with the essential requirements of the European Directive 1999/5/EC, including amendments, concerning Radio and Telecommunications terminal equipment.



The product is covered by the European directive 2002/96/EC, including amendments, concerning Waste Electrical and Electronic Equipment (WEEE). Recycle the product and its accessories according to national regulations.



Direct current.



Connector for battery charger.



Indoor use only.



Class II equipment.



Aux in.



Micro USB output.

Contents

Important Safety Instructions.....	3
Product symbols.....	5
1. Introduction.....	9
Your device.....	9
Product overview.....	10
Included accessories.....	11
2. Getting started.....	13
Charge.....	13
Start up.....	16
Use the headphones.....	16
Use the neckloop.....	17
3. Usage.....	21
Use as a conversation amplifier.....	21
Use in conjunction with a teleloop.....	22
External sound sources.....	23
4. Advanced features.....	25
Set a maximum volume level.....	26
Adjust the balance.....	27
Adjust the tone.....	27
Lock the buttons.....	28
5. Product information.....	31
Function indicator.....	31
Optional accessories.....	32
Battery maintenance.....	33
Technical specifications.....	33

6. Troubleshooting.....	35
Service and warranty.....	37
Contact information.....	39

1. Introduction

Thank you for choosing Comfort Duett™ from Comfort Audio!

This product is the result of our constant strive to improve the life of people with hearing loss all over the world.

To get the most out of your new product, please read these instructions before using it for the first time. Take special notice to the section *Important Safety Instructions* on page 3.

Your device

Comfort Duett is a small user friendly personal listener with several useful features:

- Microphone for amplifying conversations.
- Built in telecoil for listening to teleloops.
- Aux connection for connection to TV, telephone, radio, or other sound sources.

The product is powered by two AAA batteries. It comes with a charging stand that acts as a convenient holder that lets you connect to external sound sources.

Product overview

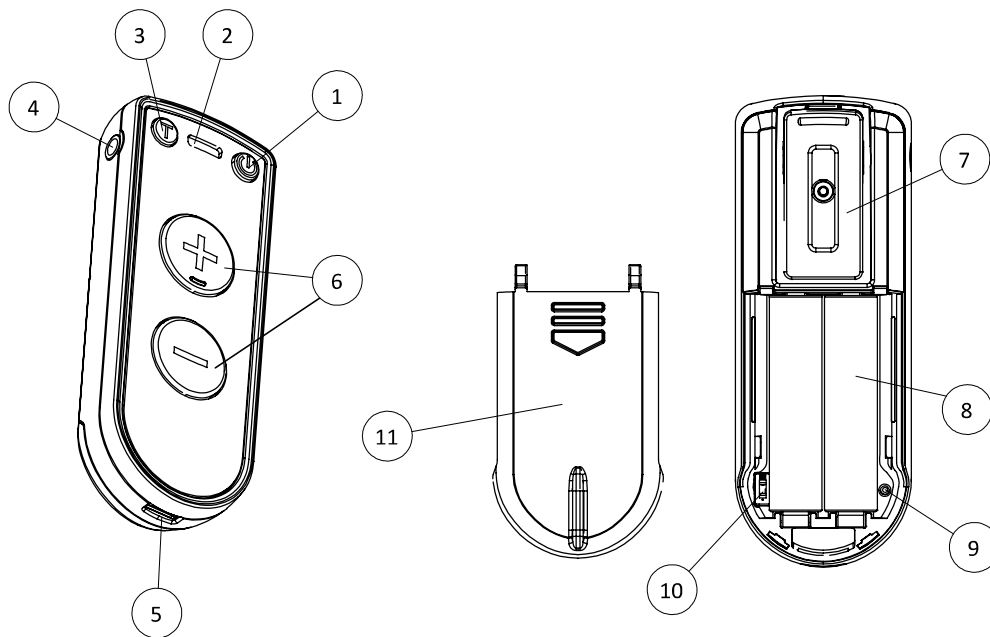

1. Power button ⏻
2. Microphone
3. T-mode button Ⓣ
4. Headphone and neckloop output
5. Charger socket
6. Volume buttons
7. Clip
8. Batteries (AAA)
9. Settings button
10. Key lock switch
11. Battery cover

Indicators

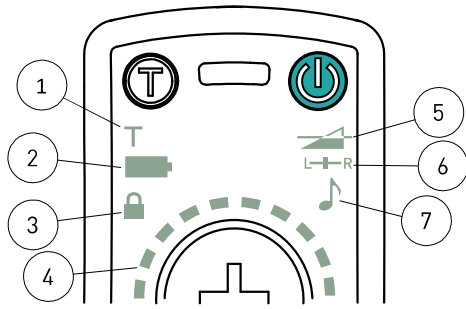

1. T-mode indicator
2. Function indicator
3. Key lock indicator
4. Volume indicator
5. Maximum volume indicator
6. Balance indicator
7. Tone indicator

Charging stand

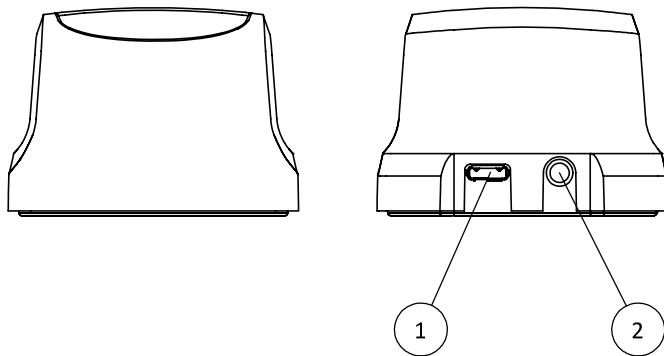

1. Charger input
2. Aux input

Included accessories

The content in your box may vary depending on what kit you have purchased (with neckloop, or headphones and earphones).

Charging stand

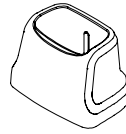

Charger

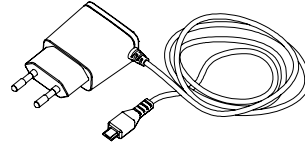

Headphones

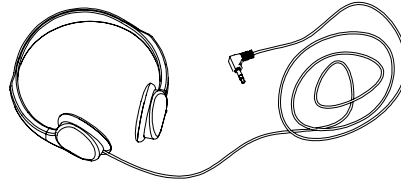

Earphones



Neckloop with adaptor

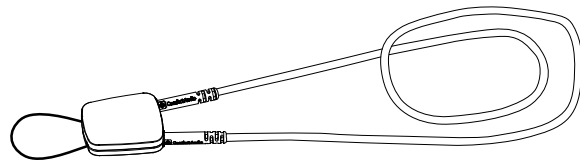

2. Getting started

This section will teach you how to perform the basic steps needed to get started.

Charge

Charging can be done at any time. If you make it routine to charge the unit whenever you do not use it, the unit is always ready for use when you need it.

1. Insert the batteries.

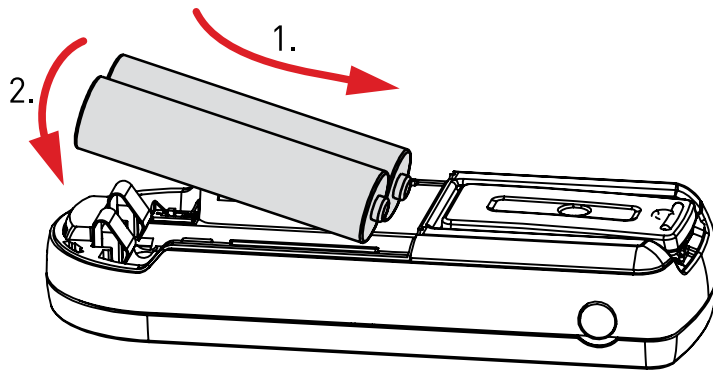

Caution: Observe the polarity. Failing to do so might damage the device.

2. Insert the supplied charger into the charger input.

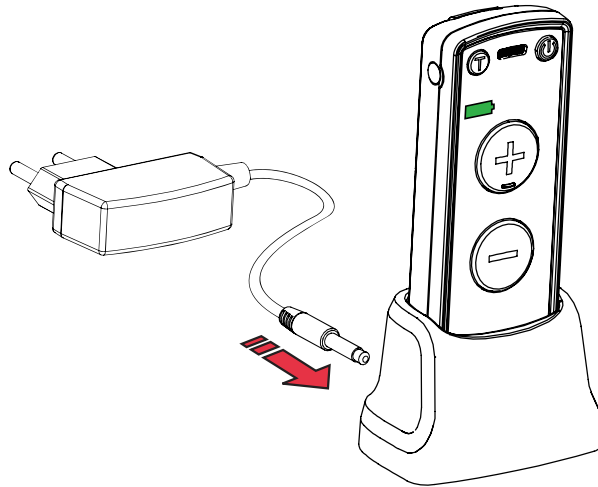

Caution: Only use the charger supplied by Comfort Audio AB. Using any other type of charger may damage your device.

3. Plug the charger into the wall socket.

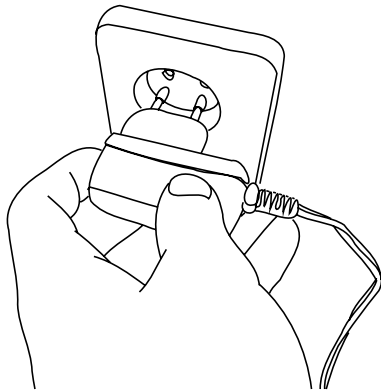

The function indicator turns orange to indicate charging.



Note: *The unit may become warm during charging, this is entirely normal. The unit is equipped with overcharging- and temperature monitoring to protect the batteries.*

The charging is done when the function indicator turns green.

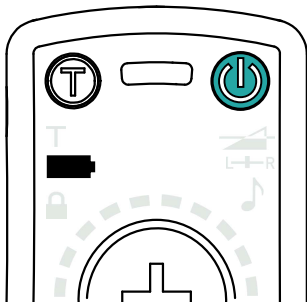

Start up

Press  until the function indicator lights up green.

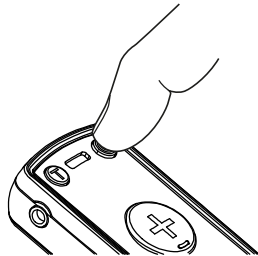

The function indicator will continue to flash every third second as long as the unit is turned on.

Use the headphones

If you are going to use headphones or earphones, they need to be connected to the unit.

Attach the headphones to the headphone output.

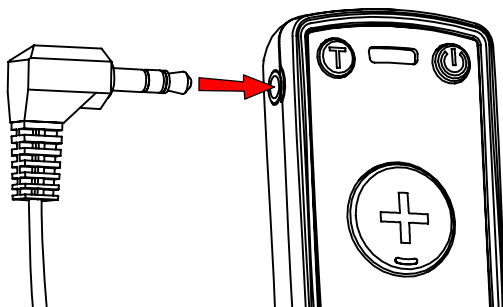

Warning: Always start listening at a low volume. Too high volume can seriously damage your hearing.

Use the neckloop

If you are going to use your product with a hearing aid or hearing implant in the T- or M/T-position, you need to connect the neckloop and wear it around your neck.

1. Attach the neckloop adaptor to your device.
 - a) Thread the clip through the rubber loop.

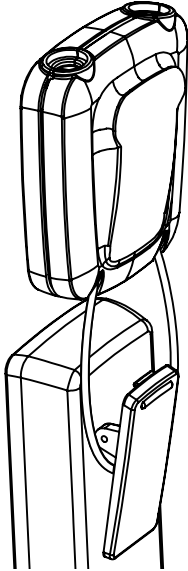

- a) Connect the short interconnect cable between the adaptor and the neckloop output.

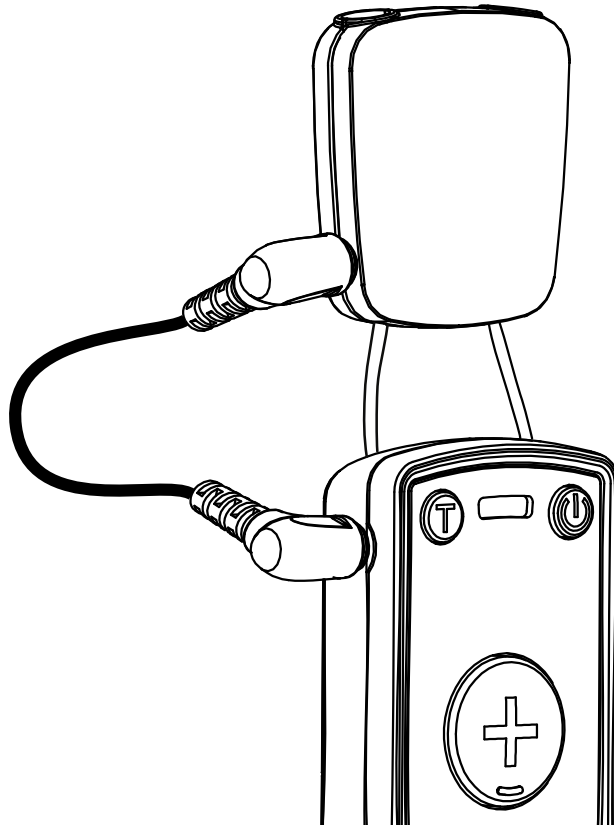

2. Connect one end of the neckloop to the sockets on the top of the adaptor.

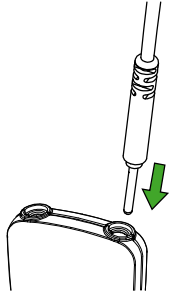

3. Place the neckloop behind your neck.



4. Connect the other end of the neckloop.



Important: Make sure the neckloop is inserted properly. Improper insertion might cause you to drop the device or damage the connections.

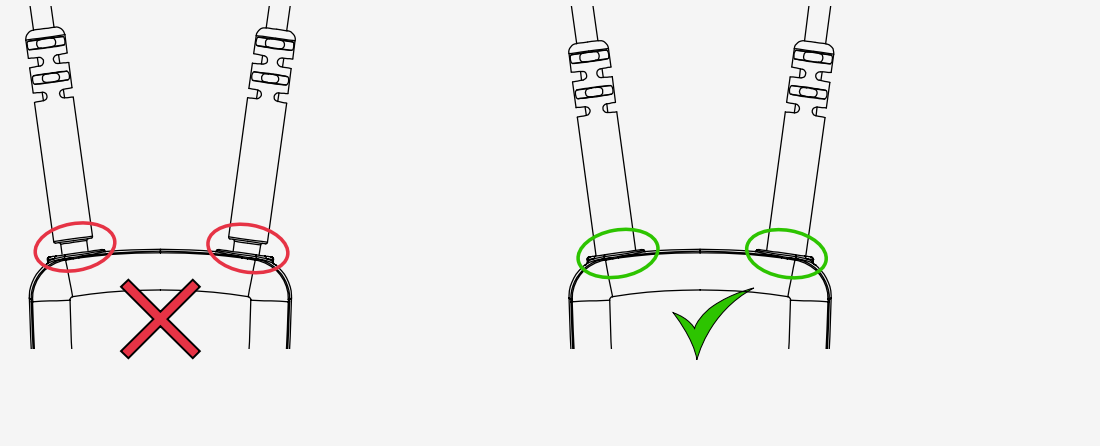

5. Switch your hearing aid or hearing implant into its T- or M/T-position.

You should now hear the sound come through your hearing aid.

3. Usage

Your product is highly flexible and well suited for several situations where good speech perception is important.



Use as a conversation amplifier

Sometimes background noise such as murmur, telephone signals and the scrape of chairs makes it difficult to hear what your friends and family are saying. Your product can be used as a

conversation amplifier to amplify the voices of persons within close range.

1. Make sure you have connected the neckloop and placed it around your neck or that you have attached the headphones.
2. Optional: If you are using a neckloop, switch your hearing aid into the T- or M/T-position.
3. Adjust the volume by using  till you find a suitable level.

Use in conjunction with a teleloop

Comfort Duett can be used to listen to a teleloop. Many public premises are equipped with teleloops. This is normally shown with a sign to the effect "These premises have a teleloop system installed".



1. Attach the headphones to the unit.

2. Activate the T-mode by pressing . The T-mode indicator will light up.

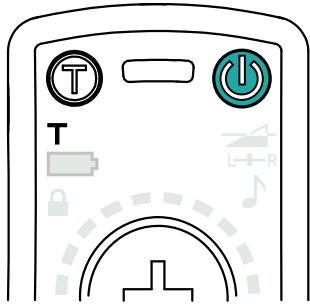

3. Adjust the volume by using  till you find a suitable level.



Tip: For best reception, use the clip to attach the device to an item of clothing, ensuring it is in a vertical position, when the T-mode is being used.

External sound sources

Most products with a line output, such as televisions and stereo equipment, can be connected to the charging stand. Connection cables are available as an accessory; see *Optional accessories* on page 32.

4. Advanced features

Comfort Duett has a number of settings that lets you tailor the unit to your specific needs. The settings are accessed through the settings button inside the battery compartment. You toggle through the settings by pressing the settings button with a small object, such as the tip of a pen.

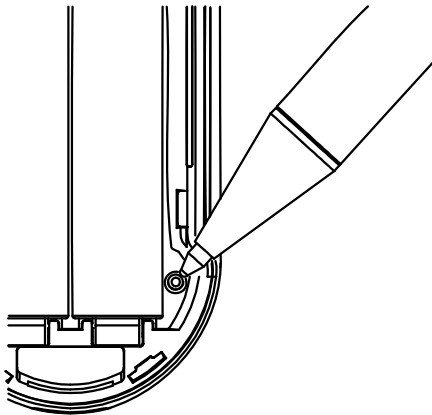

There are three different sound settings:

- Maximum volume
- Balance
- Tone

The symbol for the selected setting is displayed on the front of the unit. The settings are adjusted with .

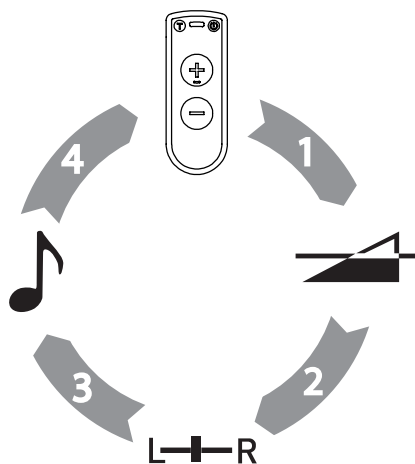

The unit returns to the normal mode automatically after 30 seconds of inactivity. Alternatively; press the settings button and advance to the normal mode to exit the settings.

Set a maximum volume level

To prevent the volume from being turned up too loud by accident, you can choose between three amplification levels.

1. Press the settings button once.
The maximum volume indicator will light up.

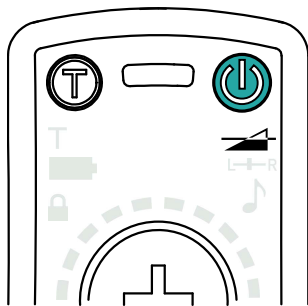

2. Use  to select between the three different levels.

3. To get out of the advanced settings, press the settings button repeatedly until you advance to the normal mode. The setting indicators on the front goes out.

Adjust the balance

You can adjust the balance between the right and left headphone to compensate differences in hearing between the ears.

1. Press the settings button twice.
The balance indicator will light up.

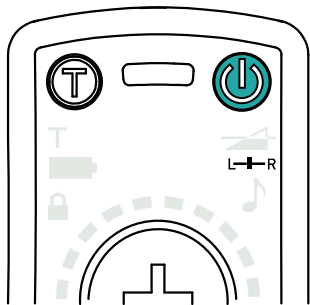

2. Use  to adjust the balance.
3. To get out of the advanced settings, press the settings button repeatedly until you advance to the normal mode. The setting indicators on the front goes out.

Adjust the tone

Depending on your type and degree of hearing loss you might prefer a different sound character than the default setting. You can select between three tone presets that emphasises different parts of the sound.

1. Bass emphasis

2. Normal
3. Treble emphasis
1. Press the settings button three times.
The tone indicator will light up.

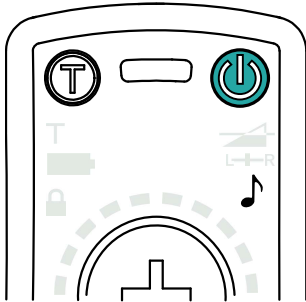

2. Use  to select between the three different presets.
3. To get out of the advanced settings, press the settings button repeatedly until you advance to the normal mode. The setting indicators on the front goes out.

Lock the buttons

If you want to avoid accidental button presses it is possible to lock all functions by activating the key lock. (You can always use the power button regardless of the key lock.)

1. Remove the battery cover.

2. Use a small object, such as the tip of a pen, to slide the key lock switch up into its *on* position.

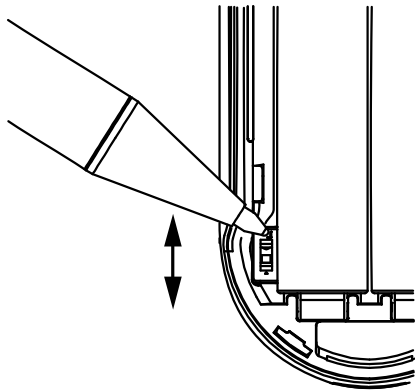

The orange keylock symbol lights up.

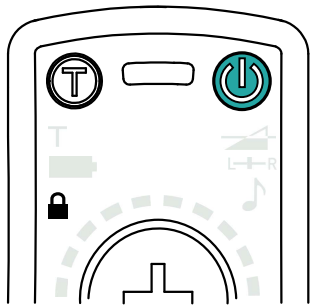

5. Product information

Function indicator

The *function indicator* gives you information about the units current status.

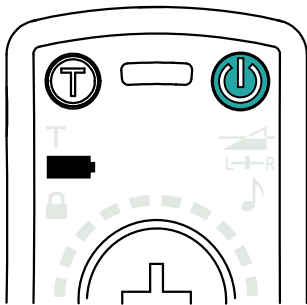

Status	Indication
Active	Repeating green flashes
Low battery	Repeating orange flashes
Charging in progress	Steady orange light
Charging complete	Steady green light
Defective battery or wrong battery type	Alternating orange and green flashes

Optional accessories

TV-kit

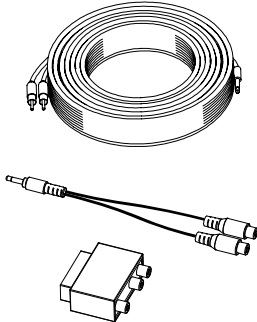

Tele-kit

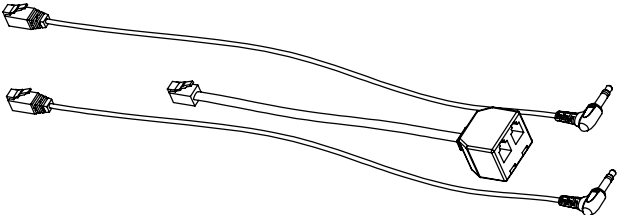

Bag

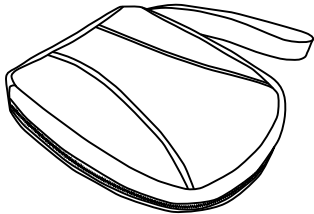

Necklace

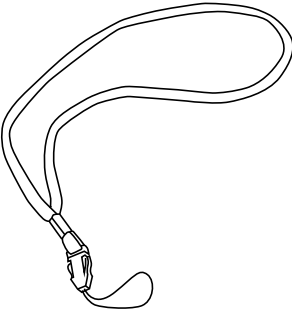

Headphones

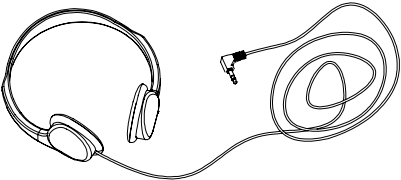

Earphones



Neckloop with adaptor

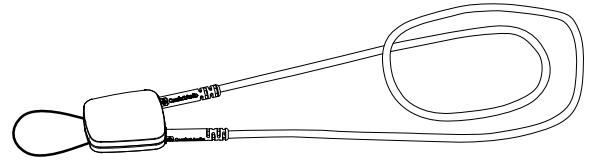

Battery maintenance

This product comes supplied with two rechargeable AAA NiMH batteries which are charged when the unit is inserted into the charging stand. NiMH batteries do not suffer from so called memory effects and do not need to be routinely discharged to preserve performance.

The batteries capacity will degrade over time. This is normal for all rechargeable batteries. Battery lifetime depends on usage patterns.

Standard alkaline batteries can also be used, but these cannot be recharged.

Technical specifications

Dimensions	94x35x17 mm
Weight	57 g
Operating time	Up to 20 hours. Dependent on usage conditions. Measured with factory settings.

Charging time	Approx. 3 hours.
Microphone	Omnidirectional.
Maximum gain	59 dB @ 1.6 kHz.
Connections	3.5 mm jack for mic/line in, headphones, or neckloop. Micro USB for charging.

6. Troubleshooting

Consult the following guide if you have problems with your equipment. If you still have questions, please contact your point of purchase.

Symptom	Cause	Solution
<ul style="list-style-type: none">• The device does not start.	<ul style="list-style-type: none">• The battery is depleted.• ⏻ is released too soon.	<ul style="list-style-type: none">• Charge the batteries.• Press ⏻ for at least 1 sec.
<ul style="list-style-type: none">• Poor speech intelligibility.	<ul style="list-style-type: none">• The distance between the microphone and the person speaking is too long.	<ul style="list-style-type: none">• Reduce the distance between the microphone and the person speaking.
<ul style="list-style-type: none">• The device will not charge.	<ul style="list-style-type: none">• The charger is not properly inserted.• The device is not properly seated in the charging stand.• There are two different types of batteries in the unit.	<ul style="list-style-type: none">• Check that the charger is correctly inserted in the wall socket and the charging stand.• Make sure that the unit is placed firmly in the charging stand.• Replace the batteries with an identical pair. Only use rechargeable NiMH batteries.

Service and warranty

Comfort Audio AB accords a limited warranty for two years as of the date of delivery. This covers all defects of manufacture and materials. For accessories and batteries the warranty period is 90 days as of the date of delivery. Local agreements or regulations may exist. Defects caused by careless handling or intervention inside the product or its accessories are not covered by the warranty.

If you are in a need of service on your device, please contact your point of purchase. You are always welcome to contact Comfort Audio if you have any questions.

Contact information

Head office

SWEDEN

Comfort Audio AB

Box 154

SE-301 05 Halmstad

Phone +46 35 260 16 00

info@comfortaudio.com

www.comfortaudio.com

Subsidiaries

DENMARK

Comfort Audio ApS

Benediktevej 5, 1.sal

DK-3480 Fredensborg

Phone: +45 33 78 03 02

info@comfortaudio.dk

www.comfortaudio.dk

NORWAY

Comfort Audio AS

Postboks 304

NO-3201 Sandefjord

Phone: +47 959 87 910

info@comfortaudio.no

www.comfortaudio.no

GERMANY

Comfort Audio GmbH
Curiestraße 2
DE-70563 Stuttgart
Phone: +49 711 67 400 224
info@comfortaudio.de
www.comfortaudio.de

BENELUX

Comfort Audio BV
Nieuwe Steen 20
NL-1625 HV Hoorn
Phone: +31 229-87 01 10
info@comfortaudio.nl
www.comfortaudio.nl

USA

Comfort Audio Inc.
411 E. Business Center Drive
Suite 109
Mount Prospect, IL 60056, USA
Phone: +1 888 421-0843
usa@comfortaudio.com
www.comfortaudio.us

Trademark and copyright notices

Comfort Audio™ is a trademark of Comfort Audio AB.

Comfort Duett™ is a trademark of Comfort Audio AB.

121220

© Comfort Audio AB. All rights reserved. All content is subject to change without notice.

Comfort Audio AB

Box 154

SE-301 05 Halmstad, Sweden

Phone: +46 35 260 16 00

info@comfortaudio.com

www.comfortaudio.com